

**IVECO**  
Drive the road of change



Born and built **around you.**

**IVECO**  **-WAY**

# Discover what's new in your IVECO S-WAY!



**XCURSOR 13 ENGINE,  
UP TO 10% FUEL SAVING**

**INTERIOR DESIGN  
AND DRIVING ERGONOMICS**

**OUTSTANDING DRIVER  
ASSISTANCE SYSTEMS**

**A WORLD FULL  
OF CONNECTED SERVICES**

# Built for your needs.

## **PROFITABILITY AND SUSTAINABILITY**

Up to 10% improvement in fuel consumption and reduced CO<sub>2</sub> emissions thanks to the new powertrain, vehicle controls and improved aerodynamics.

## **BRAND NEW INTERIOR DESIGN**

Superior onboard living thanks to a new interior design, new dashboard with customizable materials and colours, new TFT instrument cluster, new infotainment and mirrorless cameras. State-of-the-art “car-like” feeling: new more vertical steering wheel, lower driving position giving enhanced comfort and responsiveness.

## **ASSISTED DRIVE AND SAFETY**

New Highway Assist, Adaptive Cruise Control with Stop&Go, GPS-Predictive and full comprehensive set of Active Safety functionalities to protect road users at 360°.

## **IVECO SERVICES SOLUTIONS**

Mobility Solutions tailored to your needs. Better productivity and uptime with enhanced remote controls and connected services.



# Exterior style.

## Stylish in all environments.

The new IVECO logo is available in chrome or matt gun metal finishes. There are eight grille options to choose from. These include glossy finishes, metallic elements or even body-coloured allowing operators to adapt their IVECO S-Way to mirror their corporate branding. The new mirrorless camera allows for a better visibility for the driver and improves aerodynamics aiding fuel economy. The front face includes headlamps with LED daytime running lights as standard, LED headlamps available, radar for ADAS functions, steps and grab handles to access the windscreen and side air deflectors designed to keep the door and mirrors clear even in adverse weather conditions. The bumper offers a choice of plastic and hybrid solutions with a choice of colours to match the requirements of your specific mission.





## The right cab for you.

Choose from the full width AS sleeper cab with low or high roof for longer distance use or the compact AT sleeper cab with low or high roof for more regional missions. For those missions that don't require a sleeper can, the AD day cab is the ideal choice.



# A driver-centric touch and feel for superior comfort and safety.

Superior onboard living thanks to a new interior design, a new dashboard customizable, fully adjustable steering wheel, full TFT instrument cluster (10 or 12 inch) and infotainment (10 inch) and electric parking brake. State-of-the-art car like feeling: more vertical steering wheel, lower driving position for enhanced comfort and responsiveness.





### **A new interior design**

The driver and passenger's comfort is guaranteed by a choice of seats with all with full backrest. Choose from vinyl, fabric or leather, heated, air suspension, lumbar support and even seat belt colour. With the improved ergonomics with the steering wheel and controls, every driver will be comfortable.

### **Everything in its place**

Compartments for storing objects and documents, both inside and under the cab. 2 USB connections are available as standard on the dash panel. Cup and bottle holders.

### **Foldable table**

The new foldable table on the passenger side of the dash panel is ideal for those tasks in the cab that require a flat worksurface.



# The best performer in TCO.

With the IVECO S-Way you can always create the vehicle and services to meet your needs and reduce Total Cost of Ownership.







## Best performer in TCO.

Up to 10% better fuel consumption thanks to completely renovated powertrain, improved aerodynamics and state-of-the-art GPS predictive driving.

TCO is lowered to extremely competitive levels thanks to fuel consumption reduction and a world of maintenance and telematic services that are built around the customer. New XCursor 13 engine with up to 580 hp and 2.800 Nm torque, new XCursor 13 Gas 500 hp and 2.200 Nm, new rear axle ratios 2,17 and 2,06, improved and optimized gearbox logic. 3 driving modes from ECO to Power with parameters that can be customized from new, by the driver or through telematics.

## Services to improve TCO.

Advanced new features and professional services can raise the fuel efficiency of a further 4%. With 100% connectivity, the driver is always able to feel connected.

The Start Pack (standard for retail customers) includes IVECO ON Access customer portal, Uptime Monitoring & Management and the Easy Way App.

Extension packages are available for the IVECO Driver Pal which brings Alexa Auto and TomTom live for the driver together with helpful tips for safer driving. Other packages and single services are available to support our customers in improving fuel consumption and driving style. The IVECO Driver Pal is available as optional and brings driver vocal companion with Alexa technology into your IVECO vehicle for helpful tips and safer driving.



# Advanced Driver Assistance Systems (ADAS).

When technology takes care of your safety and that of other road users to give you a calm, stress-free driving experience. Level 2 ADAS systems support the driver to be more comfortable and safer.

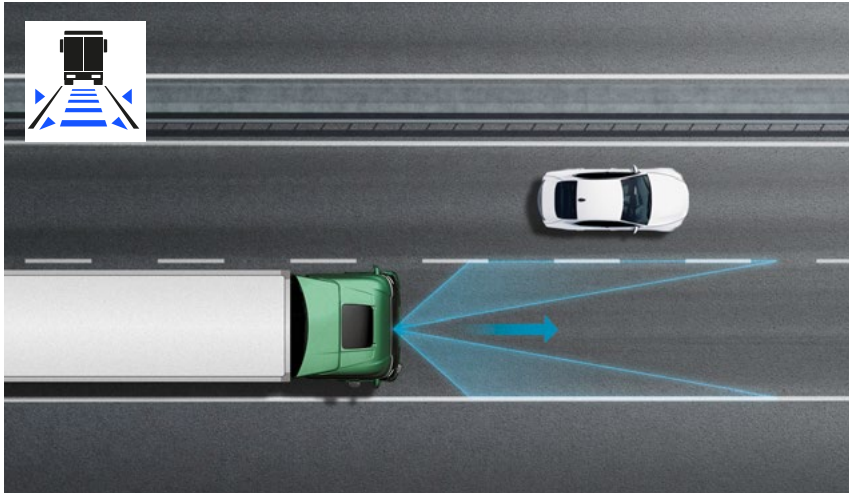

## **HIGHWAY ASSIST**

Actively supports the driver in keeping just the centre of the lane. It uses the Front Camera, Active Steering and the Capacitive Hands-off Detection. Can be automatically activated by the Adaptive Cruise Control.

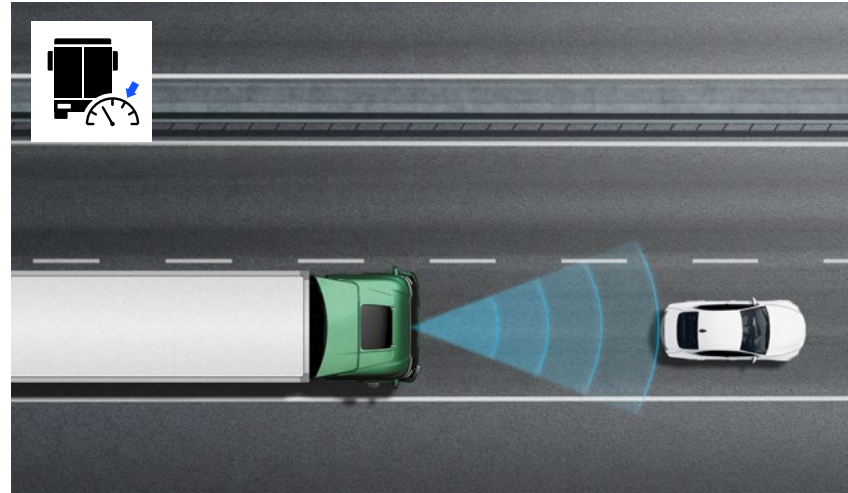

## **ADAPTIVE CRUISE CONTROL WITH STOP&GO**

Actively supports the driver in keeping fixed speed together with a safe distance to the vehicle in front. It modulates engine and braking power according to traffic conditions. It can follow vehicles in a queue with auto-restart after up to a 3 second stop.

# Outstanding driver assistance.

The latest European General Safety regulations have brought to IVECO S-Way new features for Advanced Driver Assistance Systems and protection of other road users.

## **ALC (Alcohol Interlock)**

Is an alcohol interlock standardised interface for the fitment of compatible aftermarket or OEM alcohol interlock devices.

## **ESS (Emergency Stop Signal)**

Warns the road users behind the vehicle via hazard lights, when braking heavily.

## **BSIS (Blind Spot Info System)**

Detects road users moving at 5-20 km/h speed in the nearside blind spot zone, providing visual and acoustic warnings.

## **MOIS (Moving Off Info System)**

Detects nearby road users in the front blind spot zone, providing visual and acoustic warnings.

## **REV (Reversing Detection)**

Provides a clear view of road users and obstacles behind the vehicle when reversing, thanks to a camera placed in the rear crossmember.

## **DDAW (Driver Drowsiness Attention Warning)**

Monitors the driver alertness and provide a warning when he is drowsy.



## **ISA (Intelligent Speed Assist)**

Aids the driver in observing the road speed limit, providing visual and acoustic feedback.

## **AEBS (Advanced Emergency Breaking System)**

Recognizes a potential front collision, warning the driver and slowing down the vehicle as much as possible. Guaranteed full braking from 80 to 0 km/h.

## **LDWS (Lane Departure Warning System)**

Warns the inattentive driver of the departure of the vehicle from the lane when turn indicators are not activated.

# High-efficiency engines.

New XCursor 13 diesel brings state-of-the-art powerline technologies such as Dual Flow Turbine Volute for Downspeeding, Higher fuel injection pressure (2.500 bar), New lighter cylinder block, crankshaft and camshaft, Smart auxiliaries and Friction reductions. Top Engine rating produces up to 580 hp and 2.800 Nm of torque, perfect for heavy-duty missions that require maximum performance, while 500 hp rating, with 2.600 Nm of torque is the best to maximize efficiency on long-haul missions. Engine weight has been reduced by 10%, while durability standard is now up to 1,6 million kilometres, 33% greater than its predecessor. The new High Performance Engine Brake is the best in the market, capable to substitute the Intarder in most missions.



Cursor 9



XCursor 13

## DIESEL ENGINE LINE-UP

Engine	Displacement (litres)	Turbo	Power			Torque		IVECO S-Way	
			hp	kW	rpm	Nm	rpm	AS	AT/AD
C9	8,7	WG	340	251	1.710 - 2.200	1.400	1.100 - 1.710	-	•
			360	265	1.530 - 2.200	1.650	1.200 - 1.530	-	•
		eVGT	400	294	1.655 - 2.200	1.700	1.200 - 1.655	-	•
XC13	12,9	eVGT	460	338	1.600 - 1.650	2.500	820 - 1.100	•	•
			500	368	1.600 - 1.650	2.600	843 - 1.100	•	•
			540	397	1.500 - 1.650	2.700	950 - 1.200	-	•
			580	426	1.450 - 1.850	2.800	980 - 1.450	•	-



XCursor 13 Natural Gas version produces 500 hp and 2.200 Nm of torque while achieving up to 11% fuel consumption reduction. This powerful performance comes with the environmental advantages of Natural Gas, which can help to significantly reduce vehicle emissions, with up to 90% reduction in CO<sub>2</sub> when run on biomethane.

#### NATURAL GAS ENGINE LINE-UP

Engine	Displacement (litres)	Turbo	Power			Torque		IVECO S-Way	
			hp	kW	rpm	Nm	rpm	AS	AT/AD
C9G	8,7	WG	340	251	1.600 - 2.000	1.500	1.100 - 1.600	-	•
			400	294	1.575 - 2.000	1.700	1.200 - 1.575	-	•
XC13G	12,9	eWG	500	368	1.600 - 1.700	2.200	1.000 - 1.500	•	-



Cursor 9G



XCursor 13G

# Sustainability.

Natural Gas is the most environmentally friendly fuel commercially available. IVECO's 8,7 litre C9 NG and the New XCursor 13 12,9 litre engines can be chosen. Thanks to the EU derogation, 18 t and 26 t NG vehicles can have a bonus mass to match the increase in tare weight. New CNG tanks 2x 135 litres and 2x 175 litres each side are now available. 190 kgs of methane giving a range up to 800 km. The IVECO S-Way Natural Gas is particularly at home in major cities – its low emissions mean it is allowed to drive in restricted traffic zones and its quiet operation makes it perfect for night-time work (PIEK Quiet Truck Test Certified at less than 72 dB).



## Compressed Natural Gas.

- **CNG cylinder** steel type-I: 70, 80, 115 and 148 litres available.
- **CNG packs** can be mounted to the side members, behind the cab or on top of the frame.
- **New CNG tanks** 2x 135 litres and 2x 175 litres each side. 190 kgs of methane giving a range of 800 km.
- **Side CNG** packs mounted in the most forward position to leave space for the installation of equipment.
- **NGVI+NGV2 refueling** available for the whole range.
- **Double CNG pack on the right side** available for rigids from WB 5.500 for an overall capacity of more than 1.500 litres.

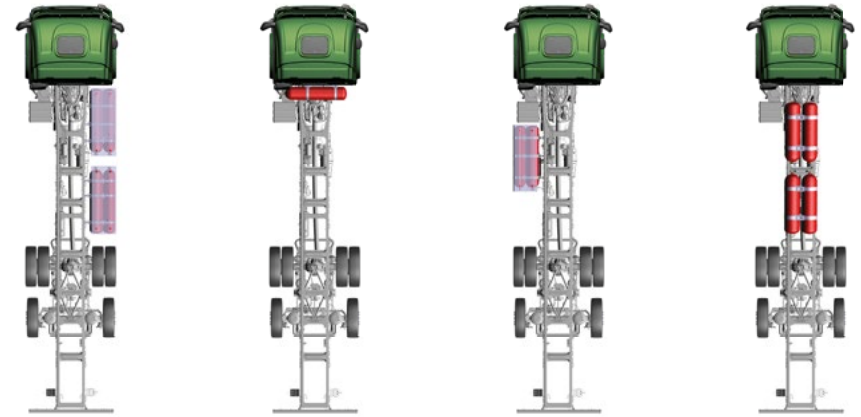

Double CNG RH side

CNG tanks behind cab

CNG tanks LH side

CNG tanks on chassis top

## Liquid Natural Gas.

- **LNG tanks** in stainless steel with 2 diameters  
26" section (660 mm): 250, 410 and 540 litres  
24" section (610 mm): 400 litres.
- **LNG packs** mounted in the most forward position to leave space for the installation of equipment.
- **Best-in-class fuel capacity** in the Market for 4x2 artics: 1.080 litres.
- **Single LNG tank** can be on the left or right.



LNG – up to 1.700 km









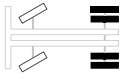
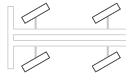
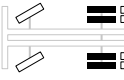
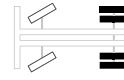
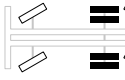
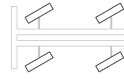

LNG – up to 1.500 km

LNG – up to 1.250 km

LNG – up to 850 km

# Line up.

Choose the **IVECO S-WAY** to suit your operation.

		ARTIC			RIGID		
IVECO S-Way Diesel		4x2	6x2C	6x2P (Twin)	4x2	6x2P	6x2C
Cab roof	AS						
	AT			-			
	AD			-			
Engine / Gearbox	C9	Automated -	- -	-	Automated / Automatic -	Automated / Automatic -	Automated / Automatic
	XCI3	Automated Automated	Automated Automated	Automated	Automated Automated	Automated Automated	-
Rear axle suspension	SR	Pneumatic / Full Pneumatic	Pneumatic / Full Pneumatic	Pneumatic / Full Pneumatic	Pneumatic / Full Pneumatic	Pneumatic / Full Pneumatic	Pneumatic / Full Pneumatic
Wheelbases (mm)		3.650 - 3.800	3.800 - 4.000	3.200 - 3.300	3.800 - 6.700	3.120 - 6.050	4.200 - 4.500

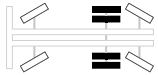

		ARTIC	RIGID			
IVECO S-Way Natural Gas		4x2	4x2	6x2P		
						
Cab roof	AS		- 	- 		
	AT	-				
	AD	-				
Engine / Gearbox	C9G	-	Automated / Automatic	Automated / Automatic		
	XC13G	Automated	-	Automated		
Fuel system	CNG	Up to 800 km	Up to 1.000 km	Up to 1.000 km		
	LNG	Up to 1.700 km	Up to 1.700 km	Up to 1.700 km		
Rear axle suspension	SR	Pneumatic / Full Pneumatic	Pneumatic / Full Pneumatic	Pneumatic / Full Pneumatic		
Wheelbases (mm)		3.800	3.800 - 6.300	5.700	3.120 - 6.050	4.200 - 6.050

# Maintenance & Repair.

You can protect the value and performance of your vehicle, and your business productivity with a Maintenance & Repair offer.

Our maintenance and repair contracts plans will maximize your vehicle's availability and you can rely on our skilled workforce and guaranteed high-quality IVECO Genuine Parts.



**Combine the M&R elements** to build a contract tailored to your needs:

## MAINTENANCE

Maintenance and lubricants, oils and fluid changes according to the Maintenance Plan as described in the customer handbook.

## DRIVELINE

Covers engine, fuel injection, gearbox, transmission propeller shaft and axle repairs.

NEW

## DRIVELINE PLUS

Provides an intermediate level of protection, adding to the DRIVELINE contract repairs to exhaust system, starter and alternator; other gearbox components, electricals and PTO Multipower.

## WEAR

Covers clutch, brake pads, brake discs, brake drums or brake linings for drum brakes.

## FULL REPAIR

Raises further the level of cover extending the DRIVELINE PLUS contract with repairs to the braking system (excluding wear components), clutch cylinder, suspension, heater, air conditioning, air compressor.

# Additional coverage.

You can further customize your cover with additional options:

## ANS 24-Hour assistance

Roadside assistance service for repairs covered by the warranty.

## Towing service

Tow truck service conveying to the nearest repair point for repairs covered by the warranty (tow truck not included).

## Auxiliary batteries

Repair and/or replacement of batteries, including ANS 24-Hour callout where covered under the maintenance agreement.

## Oil top up

Engine oil filling limited to 2 litres per 3.000 km.

## Light bulbs

Replacement of faulty lamps.

## Wiper blades

Replacement of windscreen wiper blades once a year.

# Choose and combine to fulfill your requirements:

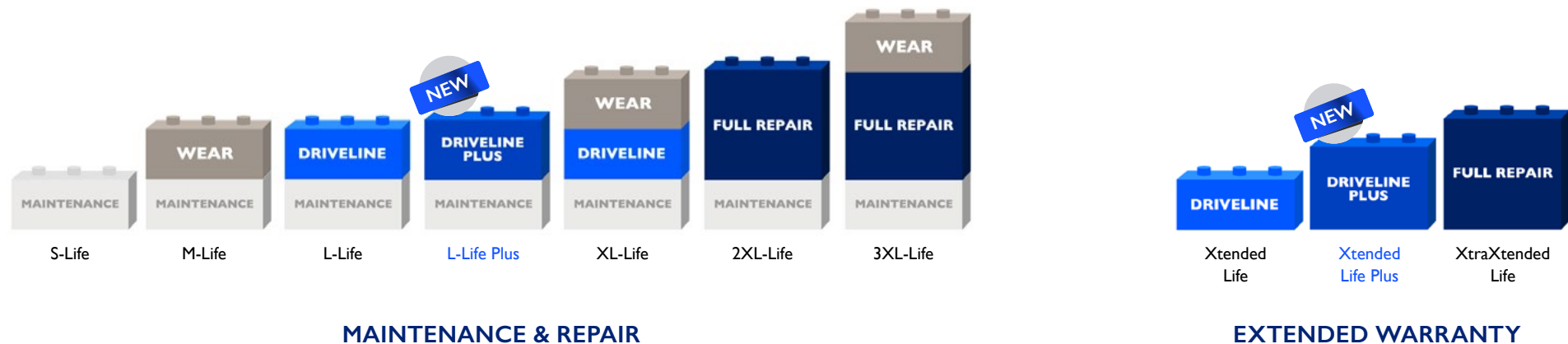

# IVECO Services Solutions.

The complete development of state-of-the-art vehicles is important to provide our customers with Mobility Solutions that best meet their needs. At IVECO, our goal is to improve the productivity and profitability of our customers' businesses. We do this by maximising vehicle uptime and efficiency, driver safety and environmental protection.



## Uptime

IVECO Uptime Services are designed to maximize your vehicle's uptime by avoiding unplanned stoppages through real-time vehicle monitoring, remote diagnostics and maintenance and repair schedules.



## Productivity & Efficiency

IVECO helps you reduce fuel consumption, optimise routes and improve your drivers' driving style through vehicle performance reporting and analysis, for a more productive and efficient business with lower running costs.



## Driver Care and Safety & Security

Improves comfort and safety levels to make the driving experience easier and more enjoyable. Driver Care services are meant to assist you throughout your journey, making your experience behind the wheel easier and more comfortable. Safety & Security services are designed to promote a safer driving style, monitor the drivers' performance and increase on-road safety.



## Parts & Accessories

Our extensive offer of high-quality parts and services enables you to customize your vehicle and enhance your life on board.



# Service bundles.

All vehicles come with the connectivity box installed, allowing you to activate the Start Pack Standard and combine it with a choice of Premium Mobility Solutions tailored to your business goals (terms and conditions apply).

## Standard

### Start Pack

A set of services aimed to simplify your life on board:

- **IVECO ON Access** for you to monitor your fleet data so to optimize performance and efficiency.
- **Uptime Monitoring & Management** to maximize your fleet availability.
- The new **Easy Way App** to make your life as a driver easier.

## Premium

### Productivity Basic Pack

You can boost your productivity by extending the Start Pack with:

- **IVECO ON Plus**, which enhances your IVECO ON experience with additional remote commands and vehicle positioning updates.
- **Professional Fuel Report** to monitor and set action plans to improve the fuel efficiency of the vehicles in your fleet.

### Driver Assistant Pack

Turn your vehicle into your ideal travel companion with:

- **IVECO Driver Pal**, which transforms your driving experience as you interact with your vehicle through vocal commands.
- **TomTom Live** for truck navigation, live traffic, and speed limit warnings.

### Driver Assistant Plus Pack

Prioritize well-being by extending the Driver Assistant pack with:

- **Driver Health Monitoring**, which monitors the driver's vital health metrics such as heart rate and provides them with recommendations, helping them look after their health.

### Safety Pack

Enhance your safety on the road and your vehicle's security with:

- **IVECO ON Plus** which enhances your IVECO ON experience with additional remote commands and vehicle positioning updates.
- **Professional Safe Report** to evaluate and help your drivers improve their driving style to be safer on the road.

### Uptime Plus Pack

Maximize your vehicle's availability and look after your driver with:

- **IVECO Maintenance & Repair** solutions tailored to your requirements to guarantee your vehicle's maximum uptime and protect your business productivity.
- **IVECO TOPCARE**, the premium assistance service designed to give your drivers peace of mind on the road with maximum support in the event of an unexpected stoppage and return your vehicle on the road as fast as possible.



IVECO

<-WAY  
500

IVECO <-WAY



## Accessories

ENHANCED EXPERIENCE

### IVECO Accessories

Customize your IVECO S-Way to perfectly match your requirements with our wide range of high-quality accessories specifically designed to boost your vehicle's efficiency and performance, increase your safety, and enhance your comfort.

**IVECO**  
00800|4|8|3|2|6|000  
Assistance Non-Stop



**IVECO Assistance Non-Stop** is just a phone call away 24 hours a day, 7 days a week to keep your IVECO S-Way and your business running.

**IVECO Non-Stop** is the original IVECO smartphone application that you can use to communicate with IVECO if your vehicle breaks down. Just insert your vehicle information (VIN and registration plate) and with a simple push of a button you can send a request for assistance to the IVECO Customer Uptime Center. We will take care of your request, activate the nearest workshop and follow up on the vehicle's repair. Through the app you can receive updates on the progress of your vehicle's assistance.

## Genuine Parts

HIGH PERFORMANCE

**IVECO Genuine Parts** will keep your IVECO S-Way performing at its best during its long years at your service – and cost-efficiently. With these parts, you will enjoy the peace of mind of knowing they have been rigorously tested for safety, consistency and reliability, and come with a one-year warranty.

## IVECO CAPITAL

**IVECO CAPITAL** is the captive financial services Brand of Iveco Group and offers a full range of financing, leasing, insurance and ancillary services for commercial and industrial vehicles. Our long-standing presence in the market as mobility financing enabler allows us to provide flexible and tailored financial solutions and dedicated bundle offers\*, to suit different customer missions and goals for a full peace of mind.

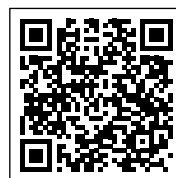

Discover more on [www.ivecocapital.com](http://www.ivecocapital.com)  
For a tailored offer contact your IVECO Dealer  
or IVECO Direct Sales.

\* Based on country' specifics. Term and condition apply.  
Finance subject to IVECO CAPITAL approval.



PUBLICATION H2331001MASTER - 02/24

The information and images in this catalogue are provided as a guideline only. IVECO reserves the right to make changes for any commercial or construction reasons at any time without notice.